

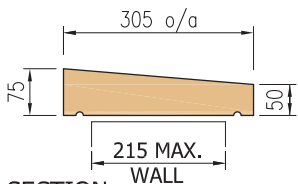

ONCE WEATHERED COPINGS



SECTION

Section type
CP1A

Weight = 38kgs/lm

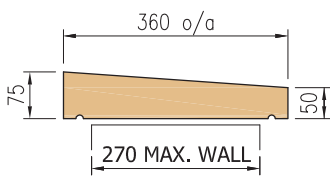

SECTION

Section type
CP1B

Weight = 45kgs/lm

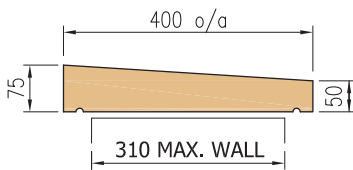

SECTION

Section type
CP1C

Weight = 50kgs/lm

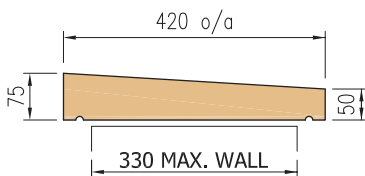

SECTION

Section type
CP1D

Weight = 52kgs/lm

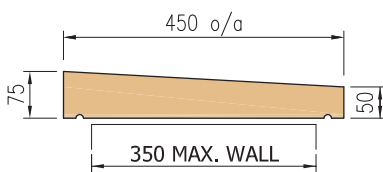

SECTION

Section type
CP1E

Weight = 56kgs/lm

Coping type
CP1

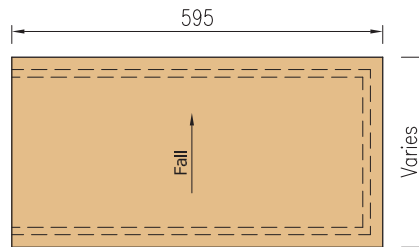

RH FAIR END (as drawn)
LH FAIR END (opposite hand)
LH/RH fair ends available to all section types.

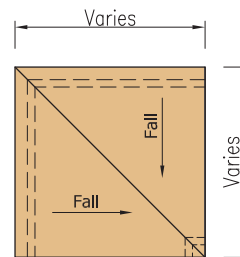

90° EXTERNAL RETURN
90° external return available to all section types.

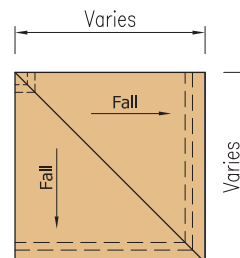

90° INTERNAL RETURN
90° internal return available to all section types.



ONCE WEATHERED COPINGS



TWICE WEATHERED COPINGS

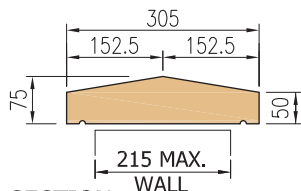

SECTION

Section type
CP2A

Weight = 38kgs/lm

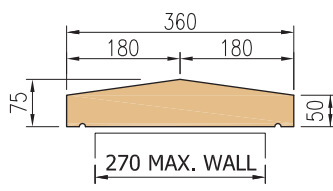

SECTION

Section type
CP2B

Weight = 45kgs/lm

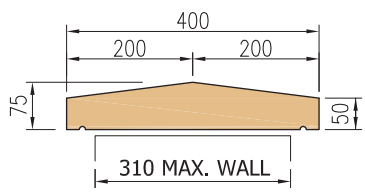

SECTION

Section type
CP2C

Weight = 50kgs/lm

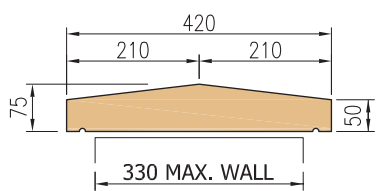

SECTION

Section type
CP2D

Weight = 52kgs/lm

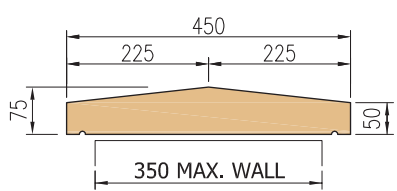

SECTION

Section type
CP2E

Weight = 56kgs/lm

Coping type
CP2

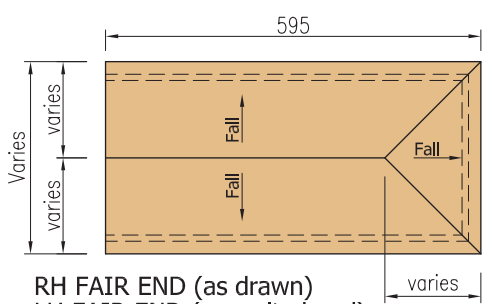

RH FAIR END (as drawn)
LH FAIR END (opposite hand)
LH/RH fair ends available to all section types.

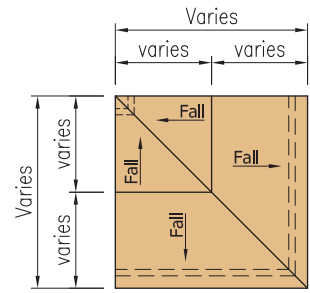

90° RETURN
90° return available to all section types.



TWICE WEATHERED COPINGS



PROFILED COPINGS

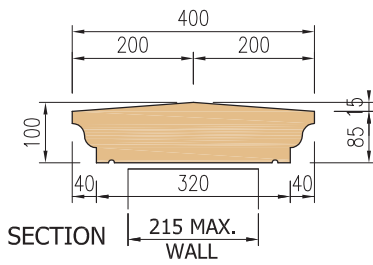

Section type
CP3A
Weight = 67kgs/lm

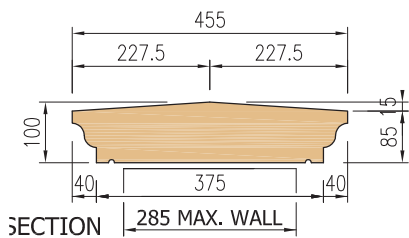

Section type
CP3B
Weight = 78kgs/lm

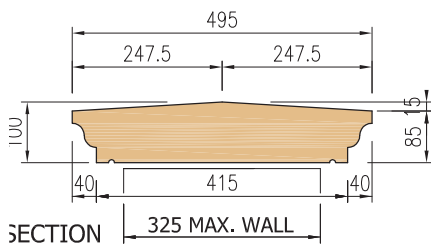

Section type
CP3C
Weight = 85kgs/lm

Coping type
CP3

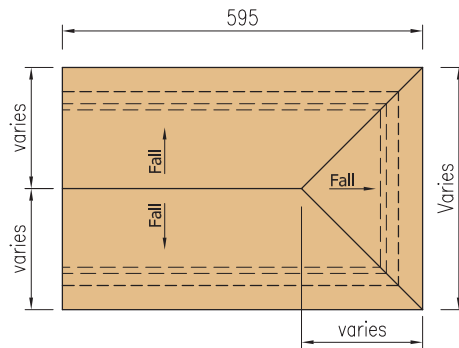

RH FAIR END (as drawn)
LH FAIR END (opposite hand)
LH/RH fair ends available to all section types.

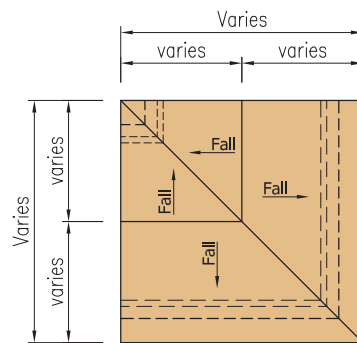

90° RETURN
90° return available to all section types.



PROFILED COPINGS



FLAT COPINGS

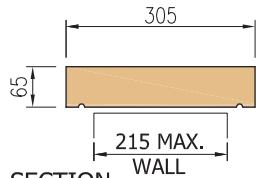

Section type
CP4A

Weight = 40kgs/lm

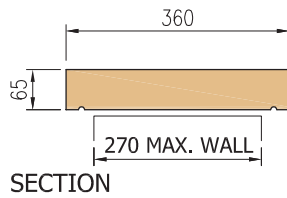

Section type
CP4B

Weight = 47kgs/lm

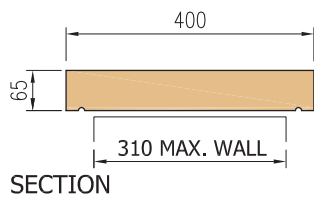

Section type
CP4C

Weight = 52kgs/lm

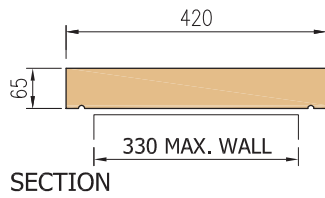

Section type
CP4D

Weight = 55kgs/lm

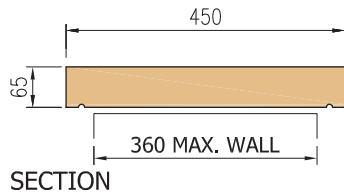

Section type
CP4E

Weight = 59kgs/lm

Coping type
CP4

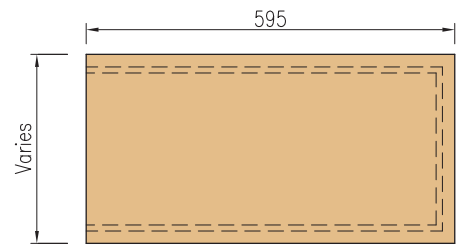

FAIR END
fair ends available to all section types.

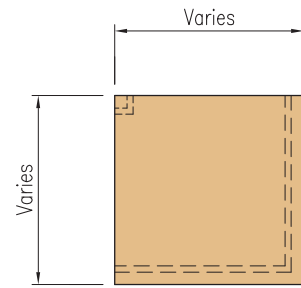

90° RETURN
90° return available to all section types.